

# 177230 Seismic Transmitter

## Datasheet

Bently Nevada Machinery Condition Monitoring

177232 Rev. O



### Description

The 177230 Seismic Transmitter is a simple, loop-powered device that can be quickly and easily installed. It can be integrated into your programmable logic controller (PLC) or controls system linked to a plant asset condition monitoring solution. Its simple design reduces training, maintenance, and service costs. The transducer helps you better manage downtime, optimize maintenance planning, and avoid unforeseen catastrophic failures of machinery assets.

The 177230 Seismic Transmitter incorporates robust CM design for reliability and implements an industry-standard 4 to 20 mA loop-powered transmitter.

### Easily Installed and Integrated

- Interfaces with PLCs and control systems (including DCS and SCADA)
- Requires only a short learning curve for operations and maintenance –through a familiar interface similar to that for connecting other PLC or control system inputs
- Requires no field configuration or adjustments
- Needs few additional parts for a complete system
- Includes technical support for customers on how to monitor their equipment
- Includes self-test
- Incorporates protected interface
- Supports a variety of interface cables

### Data Quality

- Provides accurate and repeatable data
- Uses simple data format
- Provides raw vibration signal for verification and analysis



---

## EHS Compliant

- Implements safe and ergonomic design
- Supports access to hazardous areas

## Specifications

### Electrical

Sensitivity – Main Loop (Signal One)	<ul style="list-style-type: none"> <li>■ 0.0 to 12.7 mm/s (0 to 0.5 in/s)</li> <li>■ 0.0 to 25.4 mm/s (0 to 1.0 in/s)</li> <li>■ 0.0 to 50.8 mm/s (0 to 2.0 in/s)</li> </ul> <p>± 10% FS, broadband rms (root mean square)          [4 ± 0.3 mA equals 0.0 mm/s and 20 ± 2 mA equals 25.4 mm/s]</p>
Output Format, Pin A Referenced to Pin B	4 to 20 mA current loop Velocity vibration
Excitation Voltage	12 to 30 Vdc (current limited to 40 mA)

 This product is for use with PLCs, DCS and SCADA systems that have internal power supplies which are typically current limited in the range of 30 mA to 35 mA.

Settling Time	Less than 15 seconds within 2% of final value
Connector Wiring Convention	<ul style="list-style-type: none"> <li>■ Pin A: 4-20 mA Positive Loop</li> <li>■ Pin B: 4-20 mA Negative Loop and common for Dynamic Signal</li> <li>■ Pin C: Dynamic Signal in voltage, unbuffered</li> </ul>
Frequency Response	10 Hz to 1 kHz (600 cpm to 60 kcpm) ± 10%
Sensitivity – Dynamic Signal (Signal Two)	10.2 mV/m/s <sup>2</sup> (100 mV/g) ± 20%
Output Format, Pin C	Voltage, Acceleration vibration

Referenced to Pin B

 The Dynamic Signal Negative (Pin B) requires isolation from any grounding. If this terminal is grounded, the 4-20 mA loop will short, resulting in no output.

Frequency Response	2.5 Hz to 10 kHz (150 cpm to 600 kcpm) ± 10%
Linearity	±1%
Output Bias Referenced to Pin B	2.5 V ± 0.1 V
Full Scale Range	147 m/s <sup>2</sup> (15 g's) peak
Velocity Range (see Option AA and BB)	<ul style="list-style-type: none"> <li>■ 0 – 12.7 mm/s (0 – 0.5 in/s)</li> <li>■ 0 – 25.4 mm/s (0 – 1.0 in/s)</li> <li>■ 0 – 50.8 mm/s (0 – 2.0 in/s)</li> </ul>
Mounted Resonant Frequency	Greater than 12 kHz
Transverse Sensitivity	Less than 5% of sensitivity
Sensing Element Type	Ceramic / Shear

### Environmental Limits

Operating Temperature Range	-40 °C to +85 °C (-40 °F to +185 °F)
Electrical Isolation	Greater than 10 <sup>8</sup> ohms
Isolation Breakdown Voltage	600 Vrms with less than 1 mA leakage current
Shock Survivability	9.810 m/s <sup>2</sup> (1.000 g peak), maximum drop test

 This part typically mounts directly to the machine via a stud. Customers can use this device with a magnetic base, but must take care not to “snap” the unit onto the machine. This snapping action can create a very large spike signal that can damage the electronics. Rolling the magnetic-base onto the machine greatly reduces the spike signal so that the unit should not have any issues.

Sensor Seal	Hermetically sealed
Relative Humidity of Transmitter	To 100% non-submerged
Magnetic Field Sensitivity	Less than 20 $\mu\text{m/s/gauss}$ (790 $\mu\text{in/s/gauss}$ ) peak Less than 14.7 $\text{mm/s}^2/\text{gauss}$ (150 $\mu\text{g/gauss}$ ) peak [based on 50 gauss, 50 - 60 Hz]

## Physical

Weight	131 g (4.62 oz), typical
Diameter	25.4 mm (1.00 in)
Height	66.0 mm (2.60 in)
Case Material	316L stainless steel
Connector	3-pin MIL-C-5015, 316L stainless steel
Mounting Hole	1/4-28 UNF
Mounting Threads	M6 X 1 SI M8 x 1.25 SI 1/4-28 UNF

 These stud adapters are provided with each device. For additional adapters, [see Ordering Information on page 7](#). Or contact [Bentley Nevada Tech Support](#).

Mounting Torque	4 to 7 N-m (35.4 to 62.0 in-lbf)
-----------------	----------------------------------

### Connector Wiring Convention

Pin A	4-20 mA Loop Power (Positive with reference to Pin B)
Pin B	4-20 mA Loop Return (Negative/return for Dynamic Signal)
Pin C	Dynamic Signal (Unbuffered, referenced to Pin B)

## Compliance and Certifications

### FCC

This device complies with part 15 of the FCC Rules. Operation is subject to the following two conditions:

- This device may not cause harmful interference.
- This device must accept any interference received, including interference that may cause undesired operation.

### EMC

EMC Directive 2014/30/EU

### RoHS

RoHS Directive 2011/65/EU

### Maritime

#### 330400 and 330425 only

ABS 2009 Steel Vessels Rules

1-1-4/7.7,4-8-3/1.11.1,4-9-7/13

## Hazardous Area Approvals



For the detailed listing of country and product specific approvals, refer to the *Approvals Quick Reference Guide* (108M1756) available from [Bently.com](http://Bently.com).

### CSA/NRTL/C

#### 177230

Ex nL IIC T4:  
 AEx nA IIC T4:  
 Class I, Div 2, Groups A, B, C, D.

Ex ia IIC T4:  
 AEx ia IIC T4:  
 Class I, Div 1, Groups A, B, C, D;  
 Class II, Div 1, Groups E, F, G;

	Class III, Div 1 Install per drawing 177234 T4 @ Ta ≤ 80°C
<b>200150, 200155, 200157</b>	Ex ia IIC T4 Class I, Div 1 Groups A,B,C,D  T4 @ -40°C ≤ Ta ≤ 80°C Per DWG 167535  Ex nL IIC T4 Class I, Div 2 Groups A,B,C,D  T4 @ -40°C ≤ Ta ≤ 80°C Per DWG 167535
<b>200350 (Approval Option 1)</b>	
Intrinsically Safe	Ex ia IIC T4 Class I, Division 1, Groups A, B, C and D  AEx ia IIC T4 Class I, Division 1, Groups A, B, C and D  T4 @ -54 °C ≤ Ta ≤ +121 °C (-65.2 °F ≤ Ta ≤ 249.8 °F ) Per drawing 175825
Intrinsically Safe and Non-Incendive	Ex nL IIC T4 Class I, Division 2, Groups A, B, C and D  AEx nA T4 Class I, Division 2, Groups A, B, C and D  T4 @ -54 °C ≤ Ta ≤ +121 °C (-65.2 °F ≤ Ta ≤ +249.8 °F ) per drawing 17582

## ATEX/IECEx

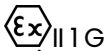
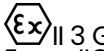
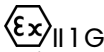
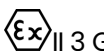
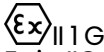
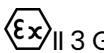
<b>177230</b>	 Ex ia IIC T4 Ga	
	 Ex na IIC T4 Gc	
	T4@ Ta = -40°C to 80°C	
	<b>Zone 0/1</b>	<b>Zone 2</b>
	Ui= 28V	Ui= 28V
	Ii= 120mA	Ii= 120mA
	Pi= 1W	Pi= 1W
Ci=0		
Li=121.06µh		
<b>200150, 200155, 200157</b>	 Ex ia IIC T4 Ga	
	 Ex na IIC T4 Gc	
	T4@ Ta = -40°C to 80°C	
	<b>Zone 0/1</b>	<b>Zone 2</b>
	Ui= 27V	Ui= 27V
	Ii= 150mA	Ii= 150mA
	Ci=16.2 nF	
Li= 0		
<b>200350</b>	 Ex ia IIC T4 Ga	
	 Ex na IIC T4 Gc	
	T4@ Ta = -54°C to +121°C	
<b>Entity Parameters</b>	<b>Zone 0/1</b>	<b>Zone 2</b>
	Ui= 28V	Ui= 28V

Ii= 200mA	Ii= 200mA
Pi= 1W	Pi= 1W
Ci=16.2 nF	
Li= 0	

## Hazardous Area Conditions of Safe Use

### ATEX/IECEx

#### Zone 0/1:

Equipment must be connected to equipment, which meets the above listed entity parameters.

The cables type A or B (in compliance with EN 60079-25) must respect the cable parameters listed with the entity parameters.

#### Zone 2 :

The supply electrical parameters shall not exceed the values mentioned in the tables above.

## Ordering Information



For the detailed listing of country and product specific approvals, refer to the *Approvals Quick Reference Guide* (108M1756) available from [Bently.com](http://Bently.com).

## Seismic Transmitter

### 177230-AA-BB-CC

#### A: Measurement Range

<b>00</b>	0 – 12.7 mm/s (0 – 0.5 in/s)
<b>01</b>	0 – 25.4 mm/s (0 – 1.0 in/s)
<b>02</b>	0 – 50.8 mm/s (0 – 2.0 in/s)

#### B: Frequency

<b>01</b>	10 Hz to 1 kHz (600 to 60 kcps) rms
<b>02</b>	3 Hz to 1 kHz (180 to 60 kcps) pk

#### C: Approvals

<b>05</b>	Multiple Approvals (CSA/NRTL/C, ATEX/IECEX)
-----------	---



Only standard or common AA-BB-CC configurations are available.

## Interconnect Cable without Armor

### 16925-AA

#### A: Length in feet

Order in increments of 1 foot (0.3 m)  
 Minimum length: 3 feet (0.91 m)  
 Maximum length: 99 feet (30.2m)  
 Example: **25** = 25 feet

These standard lengths are available. You can order custom lengths at additional cost.

Feet	Meters (approx.)
<b>10</b>	3.1
<b>12</b>	3.6
<b>15</b>	4.5
<b>17</b>	5.0
<b>20</b>	6.0
<b>25</b>	7.6
<b>30</b>	9.0
<b>99</b>	30.0

## Interconnect Cable with Armor

### 16710-AA

#### A: Length in feet

Order in increments of 1 foot (0.3 m)  
 Minimum length: 3 feet (0.91 m)  
 Maximum length: 99 feet (30.2m)  
 Example: **25** = 25 feet

These standard lengths are available. You can order custom lengths at additional cost.

Feet	Meters (approx.)
<b>08</b>	2.4
<b>10</b>	3.1
<b>12</b>	3.6
<b>15</b>	4.5
<b>17</b>	5.0
<b>20</b>	6.0
<b>30</b>	9.0
<b>99</b>	30.0

## Ordering Accessories

You can order these accessories from the vendors named. Contact the vendor with the part number and ask for their part that fits your application.

### 3-Pin Connector (MIL-C-5015)

Base	Cannon (ITT industries) <a href="http://ittcannon.com">ittcannon.com</a> P/N: CA3106R-10SL-3S F97 or P/N: MS3106R-10SL-3S
Shell	Sunbank Co. <a href="http://sunbankcorp.com">sunbankcorp.com</a> Glenair, Inc. <a href="http://glenair.com">glenair.com</a>
Wire (3-wire with shield)	Three-conductor 18 to 22 AWG cables with a 0.01" minimum outer jacket and inner wire insulation, and 80% minimum coverage shield. Insulation rating should be 600 V minimum.
Mil-W-16878/4 (Type E)	Sonic/Thermax <a href="http://thermaxcdt.com">thermaxcdt.com</a> 18 AWG - P/N: 18-TE-1930 (3) SXE 22 AWG - P/N: 22-TE-1934 (3) SXE
	Standard Wire and Cable Co. <a href="http://std-wire.com">std-wire.com</a> 18 AWG - P/N: 1100-88T 22 AWG - P/N: 1100-66T
	Belden <a href="http://belden.com">belden.com</a> 18 AWG - P/N: 83336 22 AWG - P/N: 83334

## Studs and Adapters

Part No.	Description
89139-01	M-M ¼-28 UNF to ⅜ -24 UNF standard stud
128038-01	M-M ¼-28 UNF to ⅜ -24 hex plate stud (1-⅜" X 0.25")
146396-01	F-M ¼-18 NPT to ¼-28 adapter
146394-01	F-M ¼-28 UNF to ¼-18 NPT adapter
37439-01	F-M ¼-28 UNF to ¼-28 UNF mounting base
164373	M-M ¼-28 UNF to ¼-28 UNF standard stud with brass tip
135826-01	M-M ¼-28 UNF to M10 X 1.0 standard stud



## Graphs and Figures

Dimensions shown in mm (inches) except as noted.

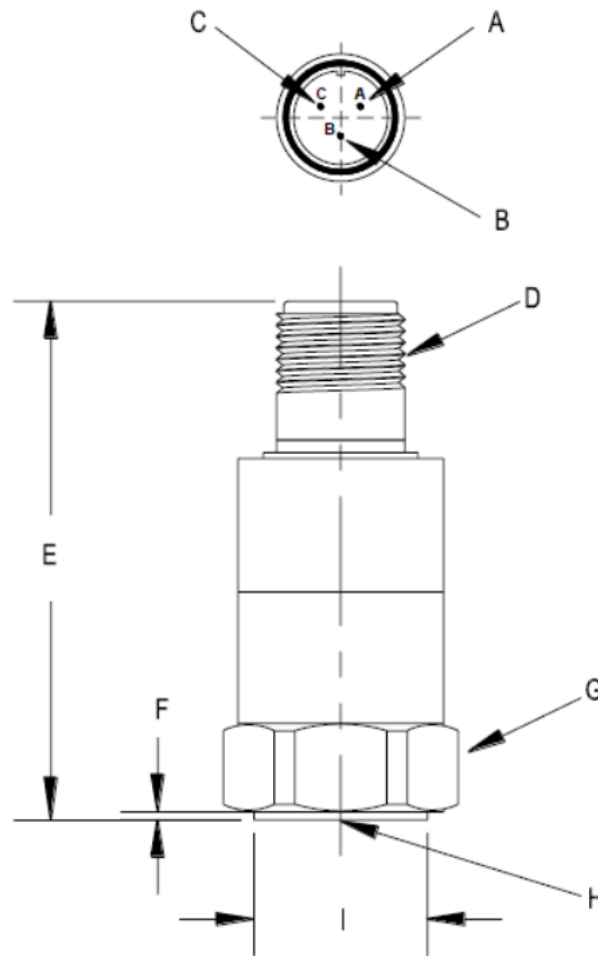

- A. Positive loop (4-20 mA)
- B. Negative loop (4-20 mA) and common for dynamic signal
- C. Dynamic signal
- D. 3-pin MIL-C-5015, 5/8-24 UNEF-2A
- E. 66.0 mm (2.60 in)
- F. 1.27 mm (0.050 in)
- G. 25.4 mm (1.00 in)
- H. 1/4-28 UNF-2B (English)
- I. 25.1 mm (0.990 in)

**Figure 1: Transducer Mechanical Outline and Dimensions**

Copyright 2020 Baker Hughes Company. All rights reserved.



Bently Nevada and Orbit Logo are registered trademarks of Bently Nevada, a Baker Hughes Business, in the United States and other countries. The Baker Hughes logo is a trademark of Baker Hughes Company. All other product and company names are trademarks of their respective holders. Use of the trademarks does not imply any affiliation with or endorsement by the respective holders.

Baker Hughes provides this information on an "as is" basis for general information purposes. Baker Hughes does not make any representation as to the accuracy or completeness of the information and makes no warranties of any kind, specific, implied or oral, to the fullest extent permissible by law, including those of merchantability and fitness for a particular purpose or use. Baker Hughes hereby disclaims any and all liability for any direct, indirect, consequential or special damages, claims for lost profits, or third party claims arising from the use of the information, whether a claim is asserted in contract, tort, or otherwise. Baker Hughes reserves the right to make changes in specifications and features shown herein, or discontinue the product described at any time without notice or obligation. Contact your Baker Hughes representative for the most current information.

The information contained in this document is the property of Baker Hughes and its affiliates; and is subject to change without prior notice. It is being supplied as a service to our customers and may not be altered or its content repackaged without the express written consent of Baker Hughes. This product or associated products may be covered by one or more patents. See [Bently.com/legal](https://www.bently.com/legal).

1631 Bently Parkway South, Minden, Nevada USA 89423  
Phone: 1.775.782.3611 or 1.800.227.5514 (US only)  
[Bently.com](https://www.bently.com)